

 **RUTUS**

METAL DETECTOR

Atrex

Multi Frequency 3.4



USER MANUAL

MAXIMIZE YOUR SUCCESS IN SEARCHING

Master Reset for Troubleshooting: If your metal detector is experiencing issues, consider performing a Master Reset to return to factory settings, which are often the most effective.

Optimal Settings for Coin Search: When searching for coins, set the Reaction to 5. Despite common misconceptions, using Filters 1 and 2 may not provide deeper detection and can reduce search effectiveness.

Sensitivity Adjustment: Adjust the sensitivity to ensure the detector operates stably. Maximum sensitivity is not always necessary or effective in all environments. A setting between 65 - 75 is typically best, especially given the high sensitivity of the Atrex model.

Enhancing Detection of Deep Targets: If deeper targets are producing faint signals, consider increasing the Volume and Audio Gain for better detection.

Dealing with High Trash Areas: In areas with a high density of objects (closer than 50 cm apart), it is advisable to use a Reaction setting of 8 or to move the coil more slowly to enhance detection accuracy.

DEAR USER!

Thank you for purchasing this product. This detector has been designed with the latest technology to allow you to make the most of your passion, to discover the remains of the past.

Atrex is a detector where you can decide how advanced the software you will be running. If you are a beginner or you like "turn on and go" products then the recommended mode is "Basic". If you require full control of the device then the recommended mode is "Multi". You will find these modes on our website under the "Software" tab.

We hope that the Atrex meets all of your expectations during your adventures. This manual will give you all the necessary information, so that you can quickly understand how the Atrex works before going into the field. Please take some time to get to know your detector, each day spent working with your detector will increase your knowledge, and steadily increase the effectiveness of your searches.

Please remember that while you are searching, you will be uncovering history. Do not destroy these unique remains in the process, take some time to get to know the law of your country and leave your search area clean and tidy.

Be an exemplary user of metal detectors:

Do not use the detector in areas that are under archaeological protection or where an archaeological dig has been conducted.

Before entering private property, ask the owner for permission.

Do not make life harder for farmers or foresters by damaging crops or disturbing animals. Do not leave a mess after yourself. Leave the place you have searched, in the same condition as when you arrived.

Refill all holes, take any rubbish with you and put it in the next rubbish bin you come across.

TABLE OF CONTENTS

DETECTOR ASSEMBLY.....	3
BATTERY INSTALLATION.....	3
CONTROL PANEL.....	4
TURNING ON/OFF.....	4
MASTER RESET.....	5
COIL BALANCE.....	5
GROUND BALANCE.....	5
DISPLAY.....	6
PROGRAM SELECTION.....	7
IDENTIFICATION.....	8
IDENTIFICATION GRAPH.....	8
SETTINGS AVAILABLE IN OPERATING MODE.....	9
SENSITIVITY.....	10
DISCRIMINATION.....	10
NOTCH.....	10
PINPOINT.....	10
OVERLOAD.....	11
OPERATION QUICK LOCK.....	11
MENU LAYOUT.....	11
MENU – ENGINE PAGE.....	12
Frequency.....	12
Electromagnetic interference preview.....	13
Hot Rock.....	13
Reaction.....	13
Small Target Boost.....	14
WiFi.....	14
MENU – AUDIO PAGE.....	16
Th Level.....	16
Th Tone.....	16
Volume.....	16
Th Sens.....	16
SAT.....	17
VCO.....	17
Audio Gain.....	17
Iron Volume.....	17
Tones.....	18
Wireless.....	19
MENU – SCREEN PAGE.....	19
Backlight.....	19
ID Type.....	20
Hold Time.....	20
ID Gain.....	20
Language.....	20
DETECTOR'S CAPABILITIES.....	20
MODES OF OPERATION.....	21
MODES OF OPERATION AND SEARCHING.....	23
SEARCHING – USEFUL ADVICE.....	24
INTERFERENCES.....	24
NOTES FOR MAINTENANCE.....	26
FACTORY SETTINGS.....	27
EU DECLARATION OF CONFORMITY.....	29

DETECTOR ASSEMBLY

The detector assembly is simple and requires no tools, a properly assembled detector is shown on the front cover of the user's manual. Before assembling the stems, make sure the cam lock is unlocked by rotating it as shown in the picture. Next push the spring buttons in and insert one stem into the other. Release the buttons and they will lock in the holes. Next secure the cam lock by turning it the other way until it is hand tight. Do not over tighten the cam locks or the screw securing the search coil. The connecting cable should be secured with two rubber cable ties to the base of the lower stem, and then wrapped around the stems. Doing this will prevent from creating loose loops of the cable in the search coil area and protect the cable from pulling out from the search coil. The third rubber cable tie should be used to attach the cable to the top of the detector, which will prevent the cable from slipping downwards. **Pay attention when inserting the cable from the search coil into the socket: the cable should not be too tight and the plug must not be inserted at an angle, as this may damage the search coil cable or plug.** See the photo on the front page for best practice. The armrest is adjustable – first remove the screw, then move the armrest to the desired position and re-tighten the screw. When disassembling the detector, begin by unplugging the search coil from the socket and loosen the cable wound around the stems. Once this is completed the rest of the detector may be disassembled into its basic components. Finish by loosening the screw securing the search coil and fold it together with the stem.

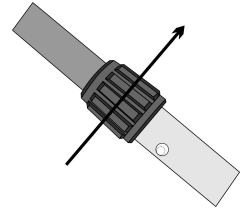

NOTE: Try to avoid creating large loops of cable near the edges of the search coil, as this may result in the detector giving false readings.

NOTE: The coil cable plug is protected by a silicon cover. This is there to prevent dirt and sand from damaging the delicate, gold connector pins. If the plug is not in the socket, it should **always** have the protective cover on.

NOTE: Cleaning the detector must be done using only water with soap on a damp sponge. Do not use any solvents or petroleum products. Regularly clean the stems and cam locks.

BATTERY INSTALLATION

Use good quality alkaline or rechargeable batteries of well-known brands. Do not mix new and discharged batteries or regular ones with rechargeable ones. Used batteries must be removed from the detector as soon as possible. Remember to remove the batteries from the detector if it is not going to be used for an extended period of time. The warranty does not cover damage caused by leaking batteries damaging the electronics.

In order to install the batteries, press the centre of the lid (2), unlock the clip (1), and then remove the lid (2) as shown on the picture. After pulling out the battery holder, insert the batteries as shown on the holder, remembering to check if the polarity is correct. It is important to make sure that the spring is pressing the batteries tightly. The holder can only be inserted into the detector one way – the shape prevents it from being inserted the other way around. When inserting the holder, the detector can turn on itself - it is not a symptom of damage.

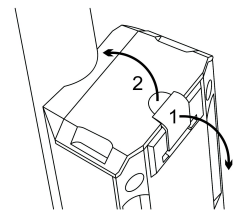

NOTE: The detector has a battery indicator which monitors the batteries charge level. As the batteries lose charge, the indicator bar will shorten. When the batteries need replacing the detector will turn off automatically. It is not possible to turn on the detector if the batteries charge is too low. As the battery reaches this level, the detector will make a sound of decreasing frequency and the display will show a symbol of a crossed out battery (see picture beside). The circuit monitoring the battery level shows a charging level of 1.5 V for standard alkaline batteries. When using 1.2 V rechargeable batteries the battery charge icon will never be full.

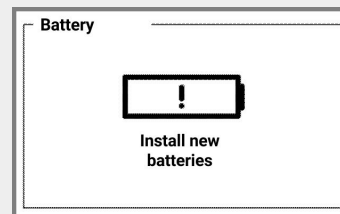

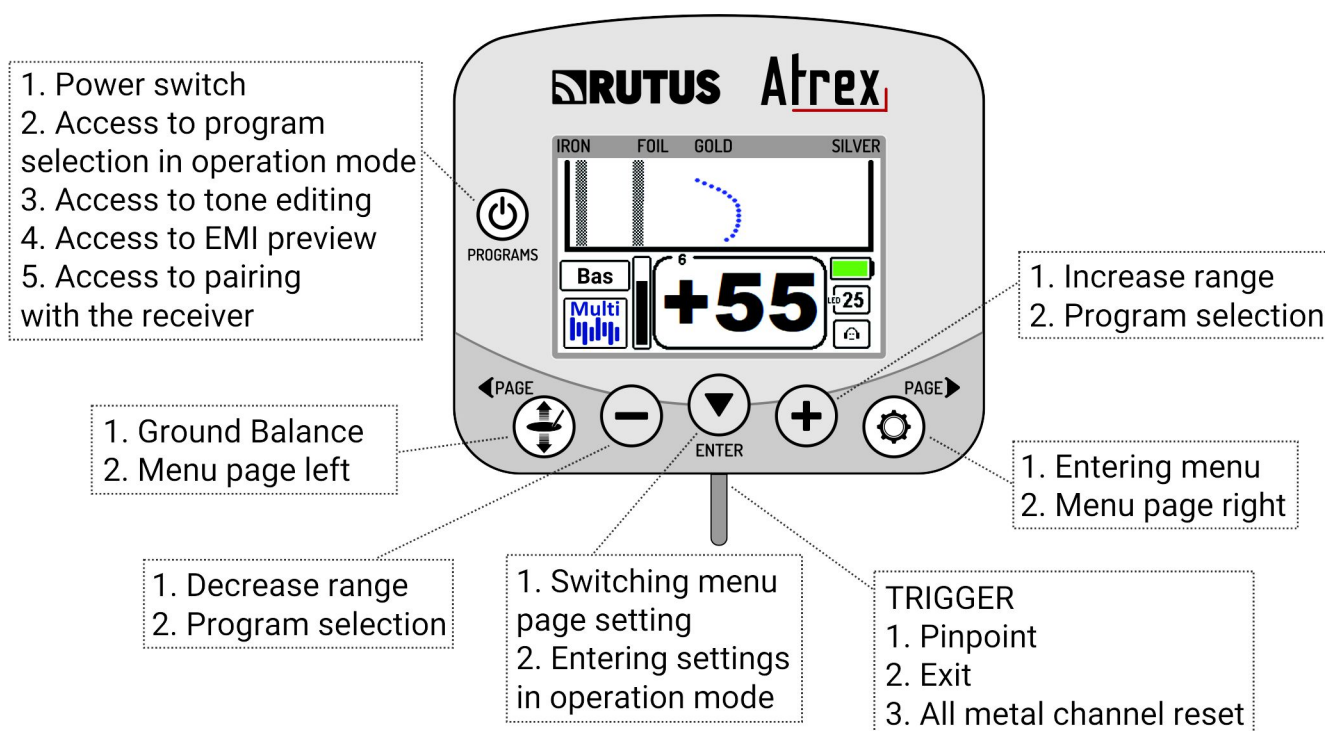

CONTROL PANEL

The picture below shows the functions of individual buttons on the control panel.



TURNING ON/OFF

The detector is turned on by pressing the button with the power icon. **The detector can be turned off only from the operation mode by holding the  button for 1 second.** In the menu screen, the  button has three functions: entering the tone editor screen, entering the EMI preview screen and entering the pairing with the wireless receiver screen. A short press of the button in the operation mode does not turn the detector off but changes to the program selection mode.

MASTER RESET

The Atrex has the ability to quickly restore all factory settings, via a Master reset.

To run the Master reset:

1. Press and hold the trigger and ▼ button before switching the detector on.
2. Turn on the detector, holding the trigger and the ▼ button all the time, also when the logo is displayed and you hear the startup sound.
3. The red "MASTER RESET" text indicates that the trigger and ▼ button can now be released - the detector has restored all settings to factory defaults.

COIL BALANCE

The detector forces the coil to balance after switching on, after changing the operating frequency or after changing the program. This is the process by which the detector prepares the coil for operation. The process is automatic and the user's role is merely to lift the coil up away from metal objects and follow the drawings that appear on the detector screen.

Coil Balance procedure:

1. Lift the coil upwards minimum 0.5 meter above the ground.
2. Pull the trigger (momentarily).
3. Wait until the "hourglass" icon disappears.

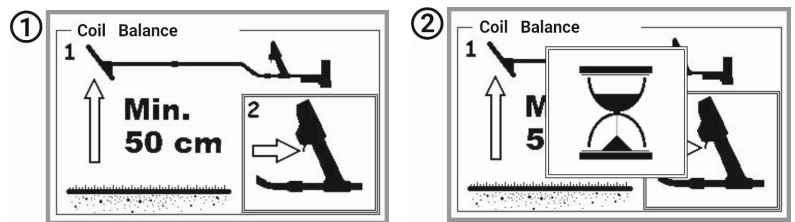

From this point you can use the detector with the factory ground pre-sets (phase -87,0) or proceed the Ground Balance (if Coil Balance is the start of a user initiated Ground Balance process).

GROUND BALANCE

Correct Ground Balance is gained by "pumping". A single Ground Balance process does not guarantee stable operation across an entire search area or for the whole of a day's searching. It is best to repeat a Ground Balance process each time a new area is started or when the detector starts to give false readings. Examples of new areas would be where field changes to forest, or when moving from a track to wetlands (on which we recommend operating with Multi Frequency).

NOTE: A non-conductive ground will give a signal phase of approximately -87.0. The more this value is shifted towards positive values, the more conductive the ground is. On high conductivity soils, the detector may become unstable at the highest sensitivity settings. This is normal and it's necessary to use the Multi Frequency work. In this situation, it may be helpful to reduce the sensitivity of the detector or work on the factory ground pre-sets.

NOTE: While balancing the coil (screen with an hourglass) the search coil must be raised a minimum of 0.5 m above the ground and away from metal objects. Ground Balance must be done at least 15 m away from other detectors. Not following these guidelines will not damage the detector, but it will cause the detector to operate less accurately – a proper Ground Balance procedure will fix this quickly.

NOTE: If you want to use the detector with factory ground pre-sets, pull the trigger when the pumping screen appears (fig. 1 below), then the screen with the ground phase -87.0 will appear and you can start searching. This is very useful if you want to quickly find an uncluttered area in order to perform correct Ground Balance by pumping.

Ground Balance procedure:

1. Press the  button.
2. Coil Balance screen will appear.
3. Lift the coil upwards minimum 0.5 meter above the ground.
4. Pull the trigger and wait until the "hourglass" icon disappears.
5. Pumping screen will appear (fig. 1).
6. Start to pump - the search coil should be slowly moved up and down above the ground, each cycle taking about a second. The detector will display the number of cycles remaining – decreasing from 5 to 1.
7. After the last movement up, the screen indicating the completion of ground balance will appear (fig. 2).
8. Pull the trigger.
9. Information about the ground will be displayed on the screen (fig. 3).
10. You can start searching.

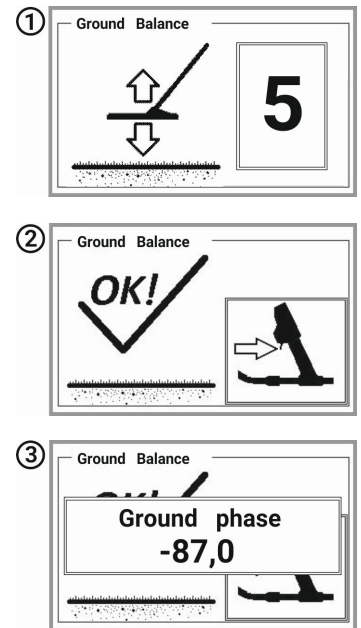

DISPLAY

The picture below shows the display in the operation mode.

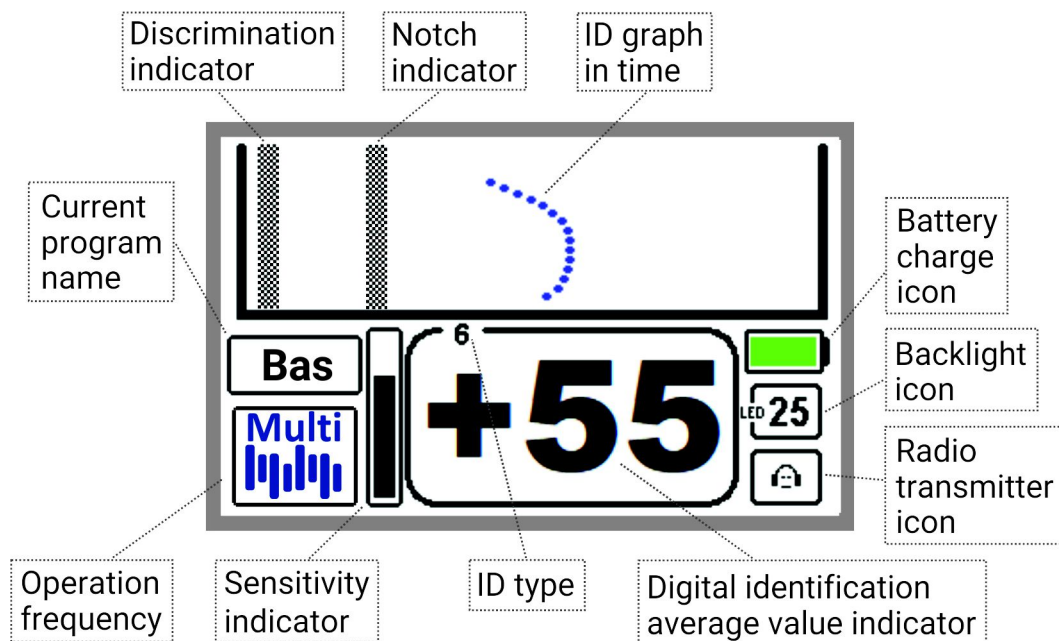

PROGRAM SELECTION

The detector has 9 factory pre-set programs designed for various types of objects as shown in the table below and 5 user programs.



On beaches and wetlands, we strongly recommend that you only work in the Beach, Swamp, Basic or User1 programs. In these programs, the Multi Frequency operation ensures that the detector does not react (or reacts many times less) to water, coke, shale and other electrically conductive non-metallic objects. The Multi Frequency operation icon on the main screen in these programs is blue, in other programs it is black.





Swamp	Program for searching for very large, very deep objects made of steel and non-ferrous metals in swamps, peat bogs, beaches and other wetlands.
Beach	Program for a classic beach searches.
Ultra deep	Program to search for very large objects at great depth made of steel and non-ferrous metals. Classic Non-motion mode without Discrimination and with graphic identification on display.
Deep	Program optimised for large steel objects at large depths, dual mode.
Big silver	Program optimised for searching for big silver and copper coins.
Basic	Universal program. If you are not sure which program to choose, this is a good programme to start with.
Coins	Program to search for coins.
Fast	Fast program to search for coins and other small non-ferrous objects amongst steel junk.
Ultra fast	Very fast program to search for coins and other small non-ferrous objects amongst steel junk.
User 1 – 5	Programs customisable by the user – this allows you to create your own programs without having to modify the factory pre-set programs. These are initially configured with Basic program settings.

NOTE: The factory programs are optimised for ease of use. When beginning to use the detector we strongly recommend trying the detector with these factory programs without changing settings in the menu. This will help you to learn quicker how the detector operates.

Each factory program can be modified to your own requirements, just enter the menu and change the settings shown. Modifications are stored after the power is switched off (however not when the battery pack is removed while the detector is turn on, which should never be done). If the changes are not what you expected, then they can be reset using the factory settings. Tables of all settings and space for noting your own are at the back of this manual.

The programs save all the setting except for the following: Backlight, Discrimination, Sensitivity, Notch, Volume and Wireless. These six settings are saved by the detector after turning the power off but are independent of the programs. The reason for separating these six settings from the programs is so that they can be changed quickly, depending on the time of day and search conditions. The user's current control over these settings is advisable and necessary.

Turning the required program on is done by pressing the  button in the detector's operating mode. The program selection screen will appear. The   buttons are used to select the program you would like, then pull the trigger to enter the program. After changing a program, a Ground Balance needs to be done, and the detector will guide you through this process.

If you want to reset a given program to the factory specifications, bring up the program selection screen (by pressing the  button) and use the  button to go down to the « Reset » option, then use the  button to choose « Yes ». Use the trigger to leave the program selection screen, the reset confirmation screen will then appear (« Really? »). Use the  button to select « Yes ». Use the trigger to complete, the chosen program will then be reset. Resetting a program to the factory settings does not result in resetting user sound profiles.

IDENTIFICATION

NOTE: To allow an intuitive approach for users of our previous products, and those of other manufacturers, Atrex has the option of choosing one of two types of identification scales. One has 120 points of ID and is the scale from 1 to 120. The second has 180 points of ID and is the scale from -90 to +90. Throughout this manual, information for the 180 scale is provided in brackets as shown [180].

Atrex is a detector which has a built-in metal object identification circuit with 120 [180] identification points. It analyses the signal from a metal object several hundred times per second, after each identification process, the internal memory of the device saves a specific digital value. The values stored in the memory are used to calculate an average identification value and an identification graph is shown. The average value depends on the characteristics of the object that is below the search coil.

When the search coil is moved over an object made of a ferrous metal (e.g. steel) the identification process will give a low value (e.g. 15 [-45]). Non-ferrous metals will give higher identification values. The value for objects will depend on their size, thickness and the type of material they are made of. Small, thin objects give values of around 40 [+10] and big, thick ones, made from good conductors will show values above 100 [+80]. The soil will also have an influence on the identification process. Rich mineral contents, and objects at great depth will influence the values against those taken from above the ground.

IDENTIFICATION GRAPH





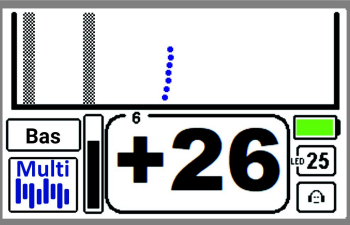
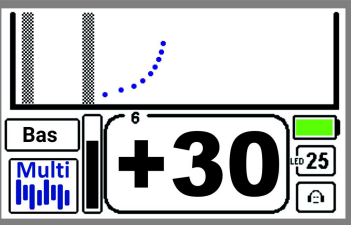
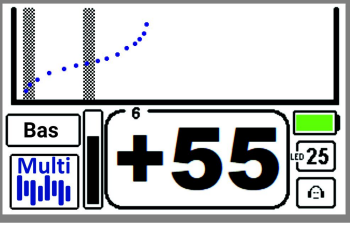
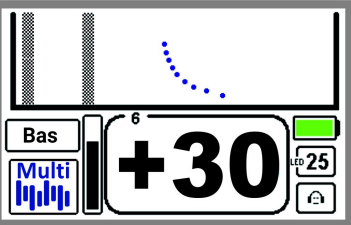
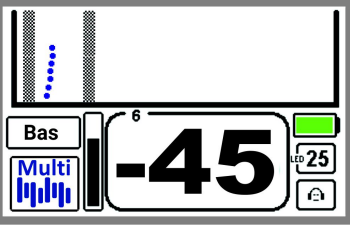
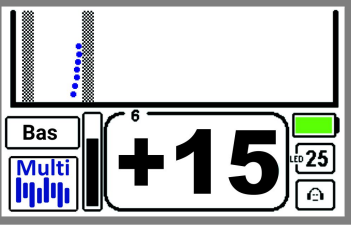











The identification graph is a graphical representation of the data collected by the identification circuit while moving the search coil over an object and is stored in the device's memory. This feature allows for quicker identification of ferrous objects than any other method. Please be aware that using the ID graph requires extensive experience. It is particularly important to become familiar with the detector so that the user can recognize the depth of the object. For deep objects, the graph will never be perfectly straight.

NOTE: When using the detector, the most important information is always the sound, then the ID number, and the graph is only supporting information.

Basic cases of graph interpretation	Cases requiring extensive user experience
 <p>If the object is shallow and the graph is straight or only slightly bent, the object is made of non-ferrous metal.</p>	 <p>For deep non-ferrous objects, the origin of the graph will bend towards the iron.</p>
 <p>If the object is located shallow and the graph clearly starts with iron and goes into the color range and the ID number is positive, we are dealing with a large iron object cheating discrimination.</p>	 <p>Depending on the type of soil, the situation may be the opposite - a deeply located non-ferrous object may form a graph with the lower part bent towards high conductors.</p>
 <p>If the graph is in the iron range and the ID number is negative, we are dealing with a iron object.</p>	 <p>There is a possible case when the graph is in the iron range and the ID number is low and indicates a low-conducting object. It is a low-conductive object masked with soil, ceramics or bricks.</p>

SETTINGS AVAILABLE IN OPERATING MODE

Adjusting the Sensitivity level, Discrimination or access to the Notch function is done straight from the detector's operating mode. The way to access the settings is described below.

After pressing the  button the « Sensitivity » message will appear on the display, a number describing the Sensitivity level and a linear scale showing the adjustment range. The adjustment is done using the   buttons. Pushing the  button a second time will show the Discrimination level. Adjusting the Discrimination is done in the same way as adjusting the Sensitivity. Another press of the  button will lead to the Notch function. The Notch point, which we want to lock (or unlock) is chosen using the   buttons. The chosen Notch point is locked using  button ( symbol will appear) and unlocked using the  button ( symbol). To quickly block or unblock a larger range of points, you can use the combination of buttons:  and  or  and  simultaneously. After pressing the  button the screen returns to the operation mode screen.

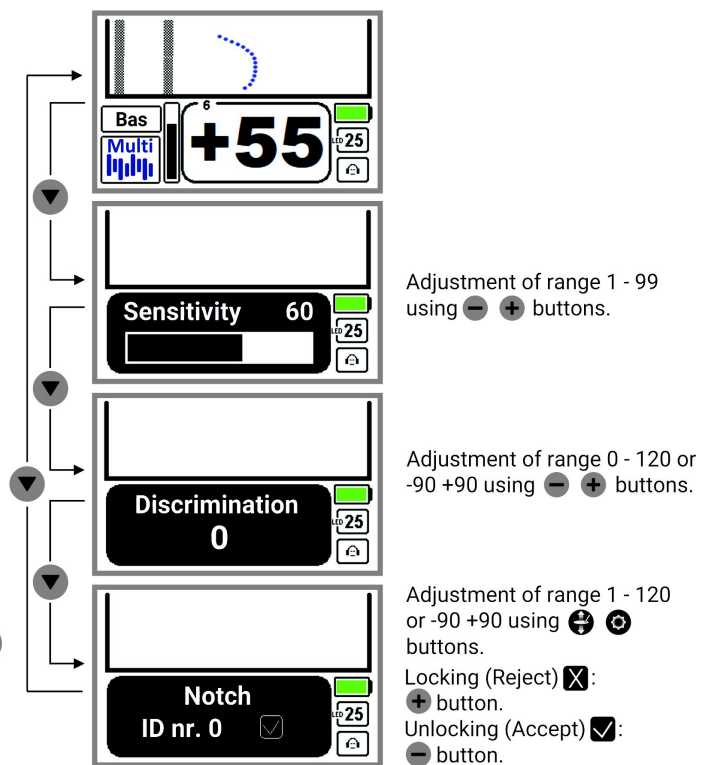

SENSITIVITY

Sensitivity in the Atrex detector may be adjusted across 99 levels. The Sensitivity level set by the user determines the detector's range and more importantly it's stable operation. In areas which are littered, freshly ploughed or have heavy electromagnetic interference, operating with maximum Sensitivity is not possible. Sensitivity has to be adjusted in accordance to the terrain where the search is being conducted and using your own experience. New users should begin their searches with the detector set to Sensitivity levels between 40 and 60. Sensitivity levels above 75 are marked in red as they are intended for advanced users.

DISCRIMINATION

Discrimination is a function which enables the removal of sound signals from unwanted objects, which have an identification number lower than the set Discrimination value. E.g. a Discrimination value set to 20 [-30] will result in a lack of the detector's reaction to most small steel objects. The Discrimination value can be set within the range 0 to 120 [-90 +90].

NOTCH

The detector has 180 points of Notch function. Each of which can be locked individually. This function is used to eliminate signals from objects with a specific identification point, which helps to search in places where there is a large amount of similar, unwanted objects. For example, to eliminate signals from spent cartridges littering a battlefield but not eliminating signals from other objects. To make best use of this function, block readings from the unwanted object's value, and a few points above and below this. The size of this range should be adjusted based on the search conditions. In places where identification readouts are stable, the range of the blocked signals should be as narrow as possible.

Using Notch it is important to remember that other objects with characteristics similar to the "unwanted" ones will also be eliminated. **For best results, only use this function in exceptional circumstances.**

If the detector is working in the 0 –120 ID range, then each ID point in the range of iron (0-29) corresponds to three selective discrimination points.

PINPOINT

This function allows for the quick and easy location of an object you have detected. To use the Pinpoint function move the search coil away from the area where the object is and then pull and hold the trigger. To pinpoint the object, make a cross like movement, to find the point where the signal is the strongest. The depth of the object shown on the screen is in centimeters and is set-up for medium-sized objects (for example coins). This means that for large objects the depth will be larger than indicated on the screen. The operation of the indicator and depth gauge is not dependent on the sensitivity of the detector, however the sound signal is.

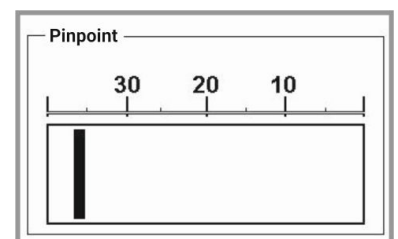



NOTE: In the Pinpoint function the detector works in Non-Motion mode.

OVERLOAD





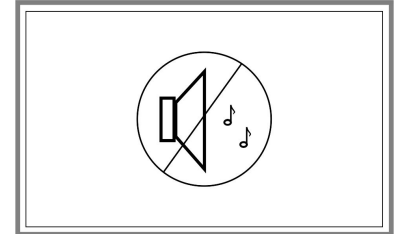

An overload means that the signal from an object is too strong for the detector to process correctly. The Pinpoint function indications and identification indications will be incorrect in this situation. Thankfully this does not mean the detector has been damaged. An overload is indicated by a rattling sound, in this situation lift the search coil up – when the overload sound has gone, the display will show the identification value for the object.

OPERATION QUICK LOCK

In the Operation screen, it is possible to quickly lock the detector's operation (sound and digital identification indications) - useful when putting the detector down, using the pinpointer to retrieve the find - and when you want to listen to the sounds of nature without turning off the detector. The  button is used to lock the operation, the  button is used to unlock.

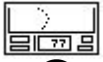

MENU LAYOUT

The menu is divided into three pages: Engine , Audio  and Screen . This allows for clear and logical grouping of settings. To enter the Menu press the , and then pull the trigger to leave. To switch between pages press the   buttons and to switch between the settings on each individual page press the  button.

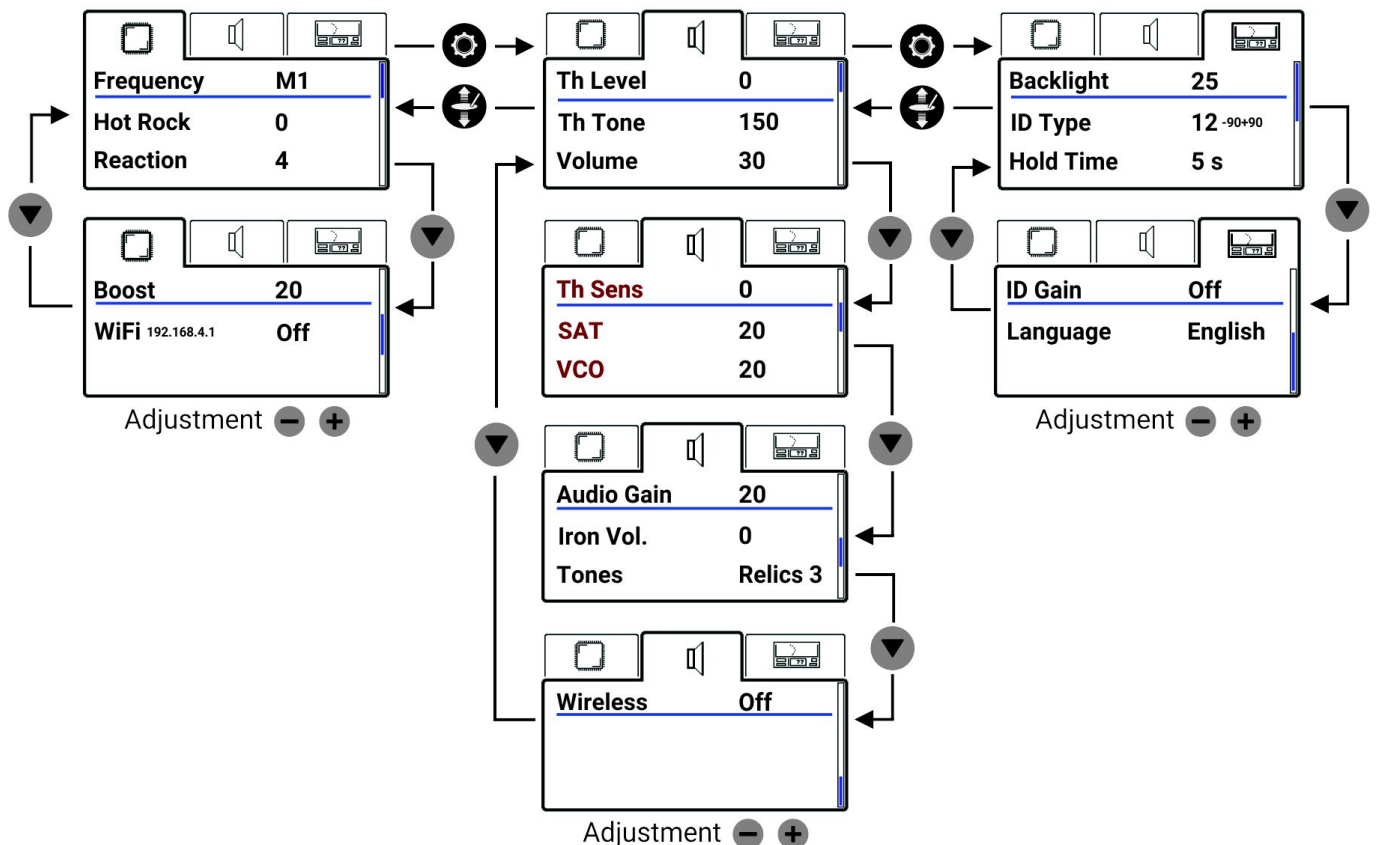

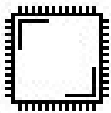

Setting	Adjustment range
Frequency	4.4 kHz – 18.6 kHz, Multi Frequency M1 – M10
Hot Rock	-30 – 30
Reaction	1 – 8
Small Target Boost	0 – 30
WiFi	On or Off

Frequency

Atrex has exceptional feature, it can be tuned across a very broad spectrum of frequencies – from 4.4 kHz to 18.6 kHz with steps of 0.2 kHz. The user can choose one of 72 available frequencies to work with. The tuning is done using the buttons.

The choice of frequency used has a very big impact on the detector's ability to detect objects. The general rule is: the smaller the object, the higher frequency used. Frequency also influences the quality of Discrimination of flat shaped steel objects, the higher the frequency, the more the properties of the metal sheets resemble those of non-ferrous metals. The frequency also has an influence on the power consumption of the device. The operating time at 4.4 kHz is much shorter than at 18.6 kHz. If you are not sure which frequency to work with – use 14 kHz.

Above the 18.6 kHz setting, the user has the option of simultaneous Multi Frequency work (M1 - M10), which operates in the range of 3.6 - 18.6 kHz. The Multi Frequency technology improves the detector's detection properties both in wet and conductive soils (on beaches) and in soils with high magnetite content. The numbers next to the letter M are sets of frequencies with slight shift, the choice is made after checking on the EMI preview (button), which set has the lowest level of interference. The detection properties of the detector are the same regardless of the number from M1 to M10 selected. **Note, however, that in the Beach, Swamp, Basic and User1 programs the Multi Frequency algorithms are optimized so that the detector does not react to water and other non-metallic conductive objects. In other programs, Multi Frequency is optimized so that it has minimal masking with iron and high sensitivity to small objects.**



Ground Balance is performed in the same way as in single-frequency operation, however the indications of the ground phase in Multi Frequency will be different. If during Ground Balance the detector does not count consecutive "pumps" and there is no audible signal it means that the level of ground mineralisation is very low and the detector should be used with the factory ground preset. After the pumping procedure, the detector automatically returns to the working screen – there is no need to use the trigger as with other softwares.

4.4 – 6.4 kHz	Deep searches for highly conductive objects e.g. large non-ferrous metal parts, large silver coins or large steel objects.
6.6 – 10 kHz	Universal search.
Above 10 kHz	Searching for small, thin objects.

NOTE: After each frequency change the detector requires the Coil Balance procedure to be repeated.

NOTE: We recommend Multi Frequency operation only with DD coils. Concentric coils (CC23 and CC12) generally do not work properly with the Multi Frequency.

Electromagnetic interference preview

In urban areas where there is high electromagnetic interference you can use the EMI preview screen to select the best frequency for the search. The EMI preview screen is accessed by pressing the  button while selecting the frequency in the menu. The height of the blue bars shows the interference level on a given frequency. Using the   buttons change the operating frequency of the detector, such that the interference is minimised. Exit the EMI preview screen by using the trigger.

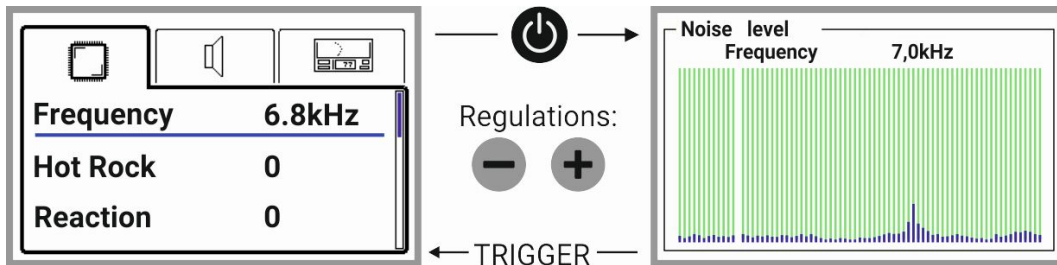

Hot Rock

This adjustment allows the detector's reaction to magnetic rocks and objects of particularly high identification value to be modified. Magnetic rocks are plain field rocks which have residual magnetic properties. Magnets do not attract them, but they influence the detector's operation. They are essentially recognized by the detector as signals with an ID value of 0 [-90] and in most cases these objects can be isolated using the Discrimination option, in the same way as simple steel scrap. Objects with exceptionally high ID values 119 or 120 [+89 or +90] are large pieces of aluminium, aluminium sheets and aluminium canteens. In this way Hot Rock adjustment can be used to set the reaction to objects at both ends of the identification scale. This is a result of the detector "virtually" connecting both ends of the scale. The microprocessor does not treat the identification scale as linear, but rather circular, where values of 0 and 120 [-90 +90] are connected, and therefore an object identified as above 0 [-90] is automatically identified as a high value object and vice versa.

Hot Rock adjustment is simply a slight tuning of the circular scale on which the detector's operation is based. In this way magnetic rocks can be set apart from the 0 value and will be more clearly discriminated (but equally the aluminium canteens will fall into the 0 [-90] value and thus are also discriminated). It is equally possible to adjust the values in the other direction: moving the large aluminium objects to lower identification values (e.g. 118 [+88]) and in this way increase the effectiveness of detecting these kind of objects but this may result in magnetic rocks giving a high, fuzzy tone. The factory setting for magnetic rocks correction is set to Neutral and this is the best setting for 99% of search areas. But if for some reason there is a need to increase the masking of magnetic rocks, use the  button to set it to negative values. The adjustment of values into the positive range will increase the detection range for canteen in the Motion mode.

In the Beach, Swamp, Basic and User1 programs, the Hot Rock should be set to 0 when using Multi Frequency. The user can make minor adjustments to this setting to change the detector's response to salt water.

NOTE: After each change to the Hot Rock adjustment the detector requires the Ground Balance procedure to be repeated.

NOTE: A setting higher than zero may cause unstable detector operation. For this reason, values above zero are displayed in red.

Reaction

This adjustment gives the ability to select the speed of soil filtering. It is an essential factor in the ability to detect large, deeply placed objects, the speed of detection and its resistance to soil mineral contents.

Filters 1 – 2	Used to search for large objects. It can, on occasion, be used to search for large coins in lightly mineralised soil (sand).
Filter 3	A universal setting, if you are not sure which filter to use – choose this one.
Filters 4 – 8	Increasingly quicker filters should be used for searching of small, thin objects amongst steel junk.

NOTE: In most cases, filter number 5 is the most effective when searching for coins.

Small Target Boost

This unique feature of the detector significantly improves the detection of coins in soils with high mineralization, in situations of masking with iron, old ceramics, bricks, etc. In areas with less ground clutter, you can maximize this function (up to a setting of 30) for better results. However, if you find yourself unearthing too many small iron objects that are ball-shaped or lump-like, it's advisable to lower this setting.

NOTE: This is a very important setting that strongly affects the detection properties. In general, settings lower than 15 should not be used.

WiFi

Atrex is equipped with a WiFi module that has its own built-in processor and memory. During normal operation of the Atrex the WiFi module is switched off. The module performs the following tasks: transfer software files from the device (laptop, tablet or phone) to the metal detector, storage of software files, main processor reprogramming.

NOTE: The Atrex detector at the time of production is programmed with the Multi software version and may not have other software files in the WiFi module.

The process of downloading the software from our website, loading it into the detector and its reprogramming does not require advanced IT knowledge and is a basic computer operation.

Software change instructions:

1. Using a laptop, tablet or phone with Internet access, open www.rutus.com.pl/en and download the appropriate version from the "Software" tab.
2. Save the software file (e.g. Basic2.0.rut) to a known location (Downloaded or desktop). Do not download the file more than once, as the system will add "(1)", "(2)", etc. to the end of the file name. If the file name is "VersaNC3.7(1).rut" instead of "VersaNC3.7.rut" then such a file will not be loaded.
3. Disconnect the coil before reprogramming the detector.
4. Switch on the WiFi module in the Atrex. The activation of the module is monitored by the detector's main processor and if successful the letters "On" will be black. The battery indicator lighting up yellow indicates that you have to replace the battery, the detector will not power on.
5. Expand the list of wireless networks on your laptop (tablet, phone) and connect to the MyRutusDetector network. If the device asks for the trust level of this network (e.g. "Is the network private or public?") then set this trust level as high as possible.

NOTE: Uncheck the "Connect Automatically" box next to your default network.

NOTE: If you are using a mobile phone, disable mobile data transmission on the phone before connecting to the MyRutusDetector network.

NOTE: Depending on what operating system your device you are using to connect to Atrex is running, the wait time for the MyRutusDetector network to appear can be several tens of seconds. In some cases, you will need to refresh the list of wireless networks.

NOTE: The MyRutusDetector network connection is not an internet connection. The detector and the devices connected to it via WiFi do not have access to the world wide web.

6. Run any web browser (e.g. Firefox, Chrome etc.) on the laptop (tablet, phone) and enter 192.168.4.1 (without "www" or "https") in the URL/Address bar and press Enter (or Go/Search depending on your browser/device).

7. A web page generated by the Atrex WiFi module will open.

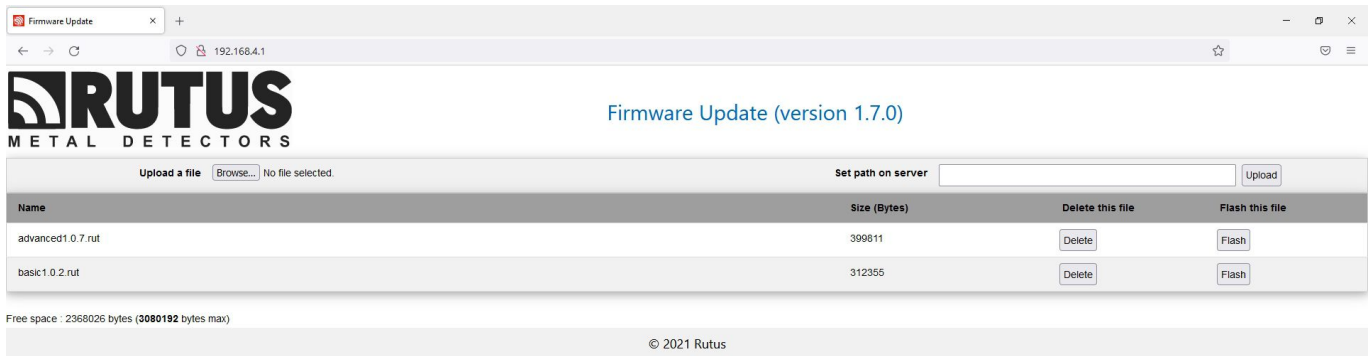

8. Using the "Browse" button, select the software file (e.g "Basic2.0.rut") from the save location (e.g from Desktop).

9. Use the "Upload" button to start uploading the file from your laptop (tablet, phone). Uploading a file can take up to a minute or two (the data transfer rate of the WiFi module is very low due to power saving).

10. When the file is uploaded, it will appear in the list of stored files.

11. The "Flash" button is used to start the reprogramming of the detector. The "Delete" button is used to delete a file from the WiFi Router memory.

12. After starting the detector reprogramming process, a page will appear on the laptop (tablet, phone) informing about the progress of this process. It takes about two minutes, during the reprogramming the image on the detector screen may disappear. After the reprogramming is completed, the detector will power off and the following page will display in your browser:

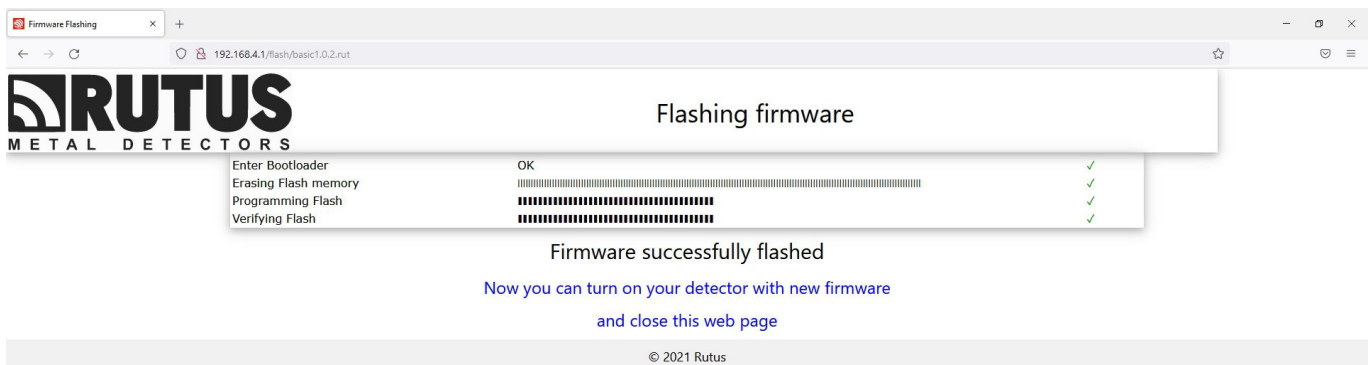

NOTE: If an error occurs during the reprogramming process, the message "Something goes wrong" will appear instead of "Firmware successfully flashed. Please try again." Use the "Go Back" button to return to the first page and start the process again. If the WiFi connection to the detector breaks, wait until the detector shuts down, as the reprogramming process will still work correctly.

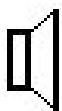

Setting	Adjustment range
Th Level	0 – 100
Th Tone	60 – 500
Volume	1 – 30
Th Sens	0 – 30
SAT	0 – 20
VCO	1 – 20
Audio Gain	0 – 60
Iron Volume	0 – 30
Tones	Pitch; Coin 1, 2, 3; Relics 1, 2, 3; User 1, 2, 3
Wireless	Off, Ch 1 – 10

Th Level

The Threshold is the background sound which is heard when Th Level is set above 0. It can be increased or decreased depending on the user's preferences and the level of noise at the search site. The level of the Threshold should be set so that it is only slightly audible – in this way you can be sure that you will hear even the quietest signals from objects. The Threshold is very important – it enables the All metal channel to be correctly reset by the user. Th Level and Th Tone adjustments can be made in the Menu at the same time as listening to the effects of these changes.

Th Tone

The Th Tone should be set as you wish – each user will have their own preferences as to the sound frequency which is the most appropriate.

Volume

To adjust the volume of the sound received from objects. The level of the Threshold is not dependent on this setting.

Th Sens

The Th Sens regulates the level of the Threshold from the All metal channel. This allows the operation mode to be modified. The detector works in Motion mode when a Th Sens is set to 0, but for higher levels the influence of the All metal channel on the level of the Threshold is also higher. **For Th Sens settings above 0 (if an Audio Gain is also set above 0), the detector switches to Dual mode.**

SAT

The SAT function reduces the effects of external conditions on the operation of the All metal channel of the detector. To put it simply: by using this setting we can prevent the detector mistuning in the sun. Another important function of SAT is changing the response of the All metal channel. For high SAT settings (especially SAT = 20) the user has the ability to audibly differentiate between a large number of small objects laying at a shallow depth from one big object. A setting of 0 means that the SAT circuit is completely turned off – detector is fully non-motion. With this SAT setting, care must be taken to ensure proper and frequent Ground Balance because the detector will signal each change in soil mineralization, especially at the transition from e.g. forest to field, as well as under the roots of large trees or near animal dens. Less skilled users can overcome this by using higher SAT values. When set to 20, the SAT function is maximally fast.

NOTE: Turning the SAT circuit on can result in a decrease in the range of the detector's All metal channel. The amount of range loss will depend on the speed at which the search coil is moved.

VCO

VCO is a function that allows the pitch of the All metal channel to smoothly change depending on the signal strength. Human hearing perfectly distinguishes even slight changes in sound frequencies – as a result, an experienced searcher is able to recognize the size and depth of the object, and in many cases can recognize their mutual position. We strongly recommend VCO setting to 20 from the very start of your experience with the detector.

Audio Gain

The Audio Gain adjustment changes how detected objects are signalled. A small Audio Gain will mean that weak signals from the Motion channel will have a quiet sound and strong signals, a loud sound. This provides "depth" in the form of sound, which allows us to hear how far from the search coil an object is located. If you set the Audio Gain to the maximum value then all signals will produce a tone of maximum loudness. At an Audio Gain setting of 0, the sounds from the Motion channel are completely blocked. This means that only sounds from the All metal channel are heard, while looking at the ID value of an object on the display. For this setting the VCO function is automatically turned on – as the power of the signal increases both the loudness of the sound and its frequency increases too. In a such manner we can obtain a fully Non-motion mode.

NOTE: It is not possible to set both the Audio Gain and Th Sens at the same time to 0. In such a case, the Audio Gain will be automatically set to 20 after exiting the menu.

Iron Volume

Iron Volume is a function that allows you to listen to signals from objects rejected by discrimination while the detector is in motion mode (Th Sens = 0). In this way, the user gets more information about the objects that are in the ground. Rejected objects are signalled by 131 Hz, which is not dependent on the tones set in the sound profiles.

NOTE: Objects rejected by Notch are not signalled by the sound of iron, and the function of the Iron Volume works only in Motion mode.

Tones





In the motion channel, the user has 9 sound profiles and a Pitch sound (variable tone depending on the signal strength) available. Sound profiles are divided into three groups: Coins: (1, 2, 3); Relics: (1, 2, 3); User: (1, 2, 3).

NOTE: Pitch sound should not be used in Dual mode - it reduces the sound clarity of the detector.

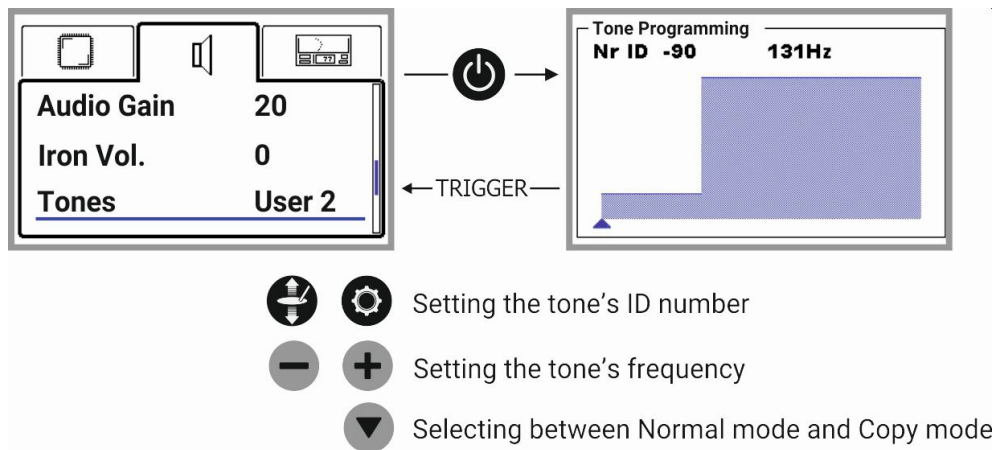
NOTE: We strongly recommend using one of the Coins profiles to search for coins and other small objects made of non-ferrous metals.

Coins and Relics profiles	Factory set profiles, which cannot be edited by the user (although they may be previewed – by pressing a button).
User profiles	These allow for sound personalization and can be edited – any tone between the range of 60 to 999 Hz can be assigned to one of the 120 identification points.



After selecting a suitable sound profile from the User group it can be edited by pressing the  button. The   buttons are used to choose the ID number for which a specific tone is applied, to change the frequency of the sound are used the   buttons. The ID number currently edited is shown by a digit and a cursor (a red triangle for the Copy mode and a blue one for the Normal mode) which are shown at the bottom of the display.

The tone editing screen can be displayed in two modes – the Normal mode and the Copy mode. Choosing a mode is done by pressing the  button. Changing the cursor's position (a red triangle) in the Copy mode results in copying the tone value from an adjacent ID position, the one the cursor was previously on. In this way it is possible to quickly set the same tone to a whole group of ID numbers.

In the Normal mode changing the cursor's position (a blue triangle) does not copy the value of an adjacent ID position. In this way it is possible to set a sound tone individually for each ID number and, if needed, listen to the whole sound profile. Changes are saved after switching off the detector's power supply.

Wireless

Atrex has a built-in wireless digital data transmitter which can work on one of 10 available radio frequencies. The design of the digital connection was made especially for our detectors – therefore there is no lag or background noise.

In order for the OS-2 receiver to work with Atrex, both devices must be paired together.

Pairing procedure:

1. Set the Wireless in the menu to "Off".
2. Press the  button in the detector's panel, the pairing screen will appear (fig. beside).
3. Turn on the OS-2 receiver.
4. The pairing screen will show numbers, these numbers are the radio address of the OS-2 receiver and the Atrex will only work with that receiver.
5. Select one of the ten channels in the detector's menu.

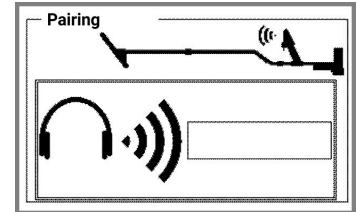

NOTE: Atrex can be paired with another OS-2 receiver at any time.

NOTE: If the Wireless is turned on and the detector is not communicating with the receiver, then a sound will start playing from the speaker automatically.

The use of the accompanying wireless devices is detailed in their respective user's manuals.

Off	The transmitter is off, the built-in speaker and headphone's socket are active.
Ch 1 – 10	The transmitter is on.

MENU - SCREEN PAGE

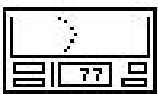

Setting	Adjustment range
Backlight	1 – 29
ID Type	Real, At 6kHz, At 12 kHz, R -90 +90, 6 -90 +90, 12 -90 +90
Hold Time	1 – 10
ID Gain	On or Off
Language	Polski, English

Backlight

Adjustment of the display's backlight. This allows searching in low light conditions.

ID Type

Identification of the type of object depending on the frequency. As the operation frequency of the detector changes, the ID value of non-ferrous objects increases and the ID value of ferrous objects is subjected to much more complex rules. It is difficult to memorize the ID's of different objects if the user has a total of 72 frequencies to choose from. This is the reason the detector has the ability to calculate the ID's to standard values for two frequencies: 6 kHz and 12 kHz or to present the Real ID.

While searching for small objects on high frequencies we suggest using the function of calculating the ID for 12 kHz – this way it is easy to recognize small differences in ID values between a foil and the desired objects. In other cases, we suggest using the function of calculating the ID for 6 kHz. The use of the Real ID function is advised only for experienced users.

The ID Type setting has 6 items. The first three positions cause the detector to work with the identification in the range of 1 - 120, the next three switch the detector to the identification system in the range -90 +90.

Hold Time

This function allows adjustment to the time that the screen shows information. In clear terrain we suggest using the high values, for littered areas the lower ones are recommended.

ID Gain

The function allows the sensitivity of the identification system to be increased. In this way, even the weakest signals are shown in digits and on the identification graph on the display. However, the user should be aware that the interpretation of graph and identification values for the weakest signals is difficult and requires a lot of experience.

Language

Allows the menu language to be chosen.

DETECTOR'S CAPABILITIES

To understand how Atrex works and it's potential, the device's flow chart below will help:

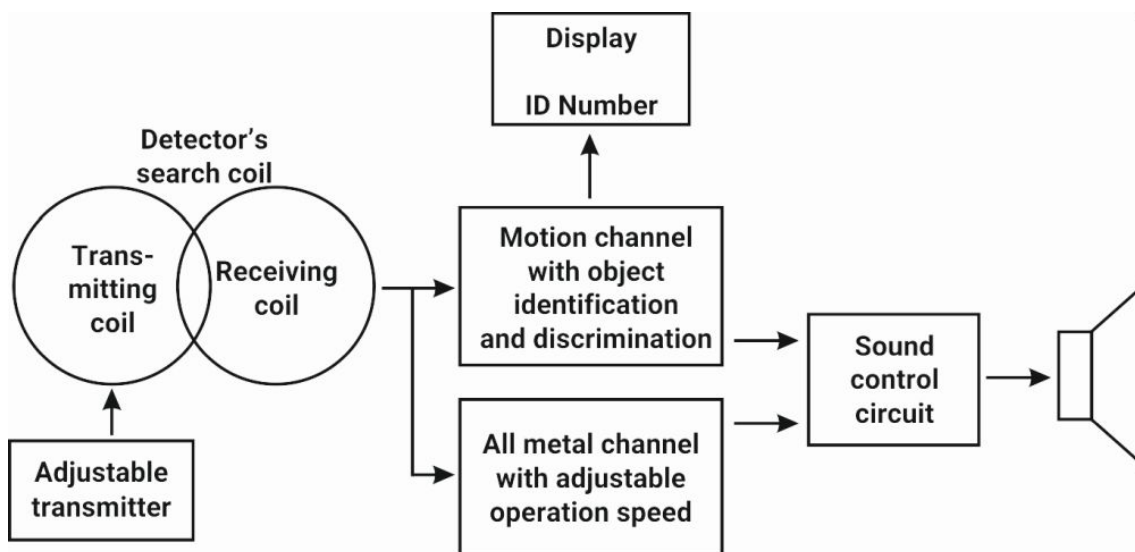

Atrex consists of several basic functional blocks: a transmitter, a search coil, a Motion Channel, an All metal channel, a sound control circuit and parts used to communicate with a user: a display and a speaker.

The transmitter controls the transmitting coil in the search coil and its operating frequency can be adjusted from 4.4 kHz to 18.4 kHz. The signal from the search coil's receiving coil (after processing, not taken into consideration in the chart above) is directed simultaneously through two channels:

1. Motion channel with object identification and Discrimination
2. All metal channel with adjustable operation speed

Signals processed in both channels are directed to the sound control circuit.

The Motion channel with object identification and Discrimination ensures the objects are properly identified. The identification result is directed to the display independently of the sound control circuit, but the sound signal is directed to the sound control circuit only when it is allowed by the Discrimination, Notch settings. The Motion channel – as its name suggests – requires that the search coil be moved relatively to the object.

The All metal channel reacts to all metal objects or, depending on the soil category (using data from ground balance) and SAT setting, can react to magnetic objects under certain conditions (so called hot rocks, ceramics, bricks etc. and objects other than the soil).

The All metal channel can be completely non-motion (SAT = 0) or it may require the movement of the search coil as the SAT parameter is increased. When SAT is set to 20, the All metal channel works as a "single-filter" Motion channel – where movement is required.

The sound control circuit chooses which signal to send to the speaker at a given moment:

- when Th Sens is set to 0, the sound from the All metal channel is blocked. As this parameter is increased, the sensitivity (and also range) of the All metal channel is increased;
- when the Audio Gain is set to 0, the sound from the Motion channel with objects identification and Discrimination is blocked. Higher values allow the sound to be passed to the speaker.

In the sound control circuit, the Motion channel with objects identification and Discrimination has priority over the All metal channel. In this way it is possible to hear the presence of all the objects (from the All metal channel) and interruptions from the Motion channel, if an object is accepted by Discrimination.

MODES OF OPERATION

This design allows the detector to work in several modes of operation:

1. Motion mode with Discrimination – a classical detector.
2. All metal Non-motion – a mode used to search for large objects.
3. All metal Motion ("single-filter") – a mode which allows large objects to be found but with the ability to separate many small objects on the surface of the ground.
4. Dual mode – Motion mode with Discrimination + All metal with any speed setting.

An important part of operating the detector is to understand the characteristics of the basic modes of operation.

1. Motion mode with discrimination

In this mode the movement of the search coil relative to the metal object is necessary. The mode is selected by setting the Th Sens to 0 and Audio Gain above 0. This gives the ability to set individual sound tones for each ID position or use the pre-set sound profiles. In this mode both identification and Discrimination work.

Discrimination

This is the ability to block sound signals for objects with conductivity (ID) lower than the set value. The Discrimination scale starts with iron and goes through foil, gold and ends with silver. A Discrimination level set to 30 [0] allows searches without detecting ferrous objects. Naturally, there will be times when the detector will signal the presence of large ferrous objects as "non-ferrous" objects. It is generally recognized that Discrimination works best for small objects at shallow depths.

NOTE: When searching for coins and other small non-ferrous objects we recommend: Coins group sound profiles and setting the Discrimination level to above 20 [-30].

Notch

This type of Discrimination allows for selective operation – the user can choose which types of objects will be indicated and which will not be.

Identification

This function is described on page 8. In practice it allows for the non-standard use of the motion operation – by setting the Discrimination to 0 [-90] and not using Notch. The detector will use sound to signal all metal objects, on the basis of the sound and the indications on the display, the user will be able to recognize all the objects in the soil. In this way the user is aware of the conditions in which they are performing the search. If using Discrimination in the Motion mode, they may not have a full view of the situation and would not be aware of how many metal objects are littering an area.

NOTE: While operating in the Motion mode with Discrimination, the trigger is used to initiate the Pinpoint option.

2. All metal Non-motion

This operating mode requires the search coil to be stationary. It works when the Audio Gain and SAT are set to 0, while the Th Sens is set above 0. The detector signals all metal objects using the sound channel. The volume and the tone of the sound, depends on the signal's strength – this gives the user information about the object's size and distance from the search coil.

When using a detector which has been well ground balanced, and by using the Th Level setting at 0 a sound signal will be received from a metal object. The only way of identifying an object is by checking the information shown on the display. **The key characteristic of this mode is that it provides the maximum detection range for all metal objects in the ground.**

NOTE: In this operating mode it is important to reset the All metal channel, this needs to be done away from metal objects. For best operation in Non-motion mode, listen to the Threshold, this should be set so that it can be heard. If the Threshold becomes inaudible then a reset is required, equally if the detector suddenly starts creating a loud sound with no apparent reason, then reset the channel.

3. All metal Motion

This All metal mode needs the search coil to be moved, for it to work the Audio Gain should be set to 0, while the Th Sens and SAT are set above 0.

As for the All metal Non-motion mode, the detector uses sound to signal all metal objects. When the search coil is stopped in close proximity to a metal object, the detector will automatically "tune" itself to the metal and stop signalling the object. How long this takes will depend on the SAT value: if SAT is set to 1 then this will be 1 second, if SAT is set to 20 – it will be approximately 0.7 seconds.

Under certain conditions, and depending on the ground balance, the detector may react to non-metallic objects. Hot rocks and other objects which have properties which are not similar to soil, may create a sound signal. An experienced user will have no problem differentiating these signals from normal signals as they have very different characteristics. The only way to identify the conductivity of these metals is to check the ID readouts on the display. The All metal Motion mode has greater range than the Motion mode with Discrimination.

NOTE: When listening to deeply placed objects it is a common mistake to swing the search coil too quickly over an object. After the search coil passes over an object and emits a sound, the Threshold will be turned down. To confirm an object has been located it is important to wait for the Threshold to return to its original level. This time can be shortened by resetting the All metal channel using the trigger.

4. Dual mode

This mode combines the Motion mode with Discrimination and the All metal mode. It is done by setting both the Th Sens and Audio Gain above 0. This combination provides the advantages of both modes – identification coming from the Motion channel and the maximum range of the All metal channel. To better understand the characteristics of the Dual mode it is best to get to know all of the other modes first before starting to use this mode.

MODES OF OPERATION AND SEARCHING

When beginning to decide which mode to use for searching, it is best to follow a few simple rules. These are only initial rules as those with a little more experience will be able to select the most appropriate for particular situations and object types.

Typical use of operation modes	Incorrect use of operation modes
To search for small objects in fields, the optimal modes will be the Motion ones (with Discrimination and All metal). The correct mode will depend on the user's expectations, if the user wants to search only for clear signals from non-ferrous metal objects, Motion with Discrimination is best. If the user wishes to find all kinds of small objects, All metal Motion mode will be better.	Motion mode with Discrimination (especially for Reaction set above 2) will not give good results when searching for very large, deeply located objects or to conduct search in places where the movement of the search coil is impossible e.g. very dense bushes, or holes.
To search for large objects at depth, the Non-motion mode is the best.	Non-motion mode will be very poor when searching for small objects in highly littered area.
For universal searches the Dual mode will be the best.	

As your knowledge of the particular characteristics of this detector increases it will become easier to choose the best mode for each terrain and searching task.

SEARCHING - USEFUL ADVICE

Searching is done by sweeping the search coil left and right as quickly as is comfortable and as close to the ground as possible. The exception to this rule is when searching for large objects using low Reaction values (1 or 2) – in this case it is best to keep the search coil 20 cm above the ground. Touching the ground with the search coil should be avoided, try to avoid hitting it against rocks and other objects protruding from the ground. While the search coil is designed to be resistant to damage when hit against hard objects, a more effective search will be had if this can be avoided.

The search coil should be held parallel to the ground, as this is very important to ensure an effective search. This is especially important when reaching the end of each left and right swinging motion, as lifting here changes the distance from the ground. This changes the level of the soil signal, which results in the filters having to process this, giving a decrease in search efficiency. Over time try to get into the habit of moving the search coil parallel to the ground.

How fast you are able to search depends on your ability to sweep, however sweeping too fast can cause a drop in effectiveness also, especially in very littered terrain. In Motion mode with Discrimination, swinging the search coil too slowly will also decrease the effectiveness, especially at higher Reaction values. For these reasons sweeping should be no slower than 0.3 m/s and no faster than 1.5 m/s.

To achieve the most accurate identification of a tiny object, the centre of the search coil should move exactly over the buried object. To do this, use the Pinpoint function, start by moving the search coil 40 – 50 cm away from the location where the object was first identified. Lift the coil slightly and then pull the trigger, then move the coil back to the area where the object was detected and try pinpointing its exact location with the strongest signal.

After determining where the object is buried, release the trigger and, while remembering where the middle of the signal is, swing the search coil so that its middle moves over the object, in quick, short movements of between 40 – 50 cm. This will confirm that the detected signal is in the middle of the search coil – and not at its edge – which could cause false identification.

It is recommended to use headphones with this detector, as they will help in shielding external noise. This will allow you to listen more closely to detector's weakest signals, increasing the technical capabilities, especially in All metal modes, where the sounds are more subtle. When searching for the deepest objects, headphones should be an essential part of your equipment.

INTERFERENCES

The Atrex detector is designed in such a way that it can be used with maximum sensitivity in places where there is no external interference. In order to achieve this highest possible stable sensitivity, two basic rules must be kept in mind:

1. Correct installation of the cable.
2. Moving the coil smoothly over the surface without jerking or hitting.

However, if there are any signals, it is worth trying to diagnose them yourself.

Checking the source of interference

Many signals appearing during searching are caused by improper settings or improper movement of the coil (jerking and hitting objects/ground). In order to verify whether the fault is user-caused or external, the following must be done:

Put the detector on the ground. If:

the detector hasn't false signals	It means that the source of the problems are settings incorrectly matched to the search conditions and NOT electromagnetic interference. In this case we recommend resetting the program to factory settings and to proceed Ground Balance. On wetlands, the Multi Frequency work should be used. If the detector continues to make unnecessary sounds, reduce the sensitivity. This should, in most cases, resolve the issue.
the detector doesn't operate stably	Walk 5 metres away from the detector. If the signal count has decreased then the source of interference may be on you e.g a telephone, pinpointer or any other electronic device.
the detector continues to emit signals by itself	Approach the detector without a telephone or any electronic devices and check the level of signals that the detector sees by Noise level preview screen. If you see that the frequency at which you are operating has a lot of interference (the blue bar is high), you should change the frequency to another one where the interference is as low as possible. It may also be necessary to reduce the detector's sensitivity.

Sources of external interference include: houses and the electrical devices inside them, power lines, other metal detectors, telephones, walkie-talkies and even stormy weather. To have certainty that the interference is external, even though there are no visible emitters within a radius of several hundred metres, you can conduct another interesting test.

Put the beeping detector on the ground, wait a few seconds to make sure it is still audible, approach again and lay the detector coil flat to the ground, then walk away again. If the signals decrease or become silent, we can be sure that the interference is caused by an external source that we are not able to see. The most common are lightning discharges, which can be up to 100 km away.

NOTES FOR MAINTENANCE

- ! The detector must be turned off before exchanging the search coil or batteries.
- ! The device must not be stored with depleted regular or rechargeable batteries installed. When the device is to be stored for more than a month, the cells must be removed regardless of their charge status.
- ! The detector must not be subjected to high temperatures – leaving the detector on a hot day in a car may damage it.
- ! Do not store the detector in an unheated room during the winter. The best place to store the detector is in a dry room, at room temperature.
- ! The search coil is waterproof to a depth of 1 m, the detector electronics are not waterproof.
- ! Cleaning the detector must be done using only water with soap on a damp sponge. **Do not use any solvents or petroleum products.** Regularly clean the stems and camlocks.
- ! If you use wired headphones – remove the plug from the headphone socket at the end of each search as transporting a detector with the plug plugged in increases the risk of damaging the socket.
- ! In difficult weather conditions it is advised to use a cover for the control panel and the battery compartment.
- ! Correct maintenance of the detector will increase its reliability and longevity.

FACTORY SETTINGS

SWAMP PROGRAM			BEACH PROGRAM			ULTRA DEEP PROGRAM		
Page	Setting	Factory value	Page	Setting	Factory value	Page	Setting	Factory value
Engine	Frequency	M1	Engine	Frequency	M1	Engine	Frequency	5.0 kHz
Engine	Hot Rock	0	Engine	Hot Rock	0	Engine	Hot Rock	10
Engine	Reaction	3	Engine	Reaction	4	Engine	Reaction	1
Engine	Boost	0	Engine	Boost	10	Engine	Boost	0
Audio	Th Level	10	Audio	Th Level	0	Audio	Th Level	20
Audio	Th Tone	150	Audio	Th Tone	150	Audio	Th Tone	100
Audio	Th Sens	30	Audio	Th Sens	0	Audio	Th Sens	30
Audio	SAT	20	Audio	SAT	20	Audio	SAT	5
Audio	VCO	20	Audio	VCO	20	Audio	VCO	20
Audio	Audio Gain	20	Audio	Audio Gain	20	Audio	Audio Gain	0
Audio	Iron Vol.	0	Audio	Iron Vol.	0	Audio	Iron Vol.	0
Audio	Tones	Relics 3	Audio	Tones	Relics 3	Audio	Tones	Relics 3
Screen	ID Type	12 (-90+90)	Screen	ID Type	12 (-90+90)	Screen	ID Type	12 (-90+90)
Screen	Hold Time	5s	Screen	Hold Time	5s	Screen	Hold Time	5s
Screen	ID Gain	Off	Screen	ID Gain	Off	Screen	ID Gain	Off

DEEP PROGRAM			BIG SILVER PROGRAM			BASIC PROGRAM		
Page	Setting	Factory value	Page	Setting	Factory value	Page	Setting	Factory value
Engine	Frequency	7.0 kHz	Engine	Frequency	5.0 kHz	Engine	Frequency	10.0 kHz
Engine	Hot Rock	0	Engine	Hot Rock	0	Engine	Hot Rock	0
Engine	Reaction	3	Engine	Reaction	3	Engine	Reaction	4
Engine	Boost	0	Engine	Boost	0	Engine	Boost	10
Audio	Th Level	10	Audio	Th Level	5	Audio	Th Level	0
Audio	Th Tone	150	Audio	Th Tone	250	Audio	Th Tone	150
Audio	Th Sens	30	Audio	Th Sens	30	Audio	Th Sens	0
Audio	SAT	5	Audio	SAT	5	Audio	SAT	20
Audio	VCO	20	Audio	VCO	20	Audio	VCO	20
Audio	Audio Gain	20	Audio	Audio Gain	20	Audio	Audio Gain	20
Audio	Iron Vol.	0	Audio	Iron Vol.	0	Audio	Iron Vol.	0
Audio	Tones	Relics 3	Audio	Tones	Relics 3	Audio	Tones	Relics 3
Screen	ID Type	12 (-90+90)	Screen	ID Type	12 (-90+90)	Screen	ID Type	12 (-90+90)
Screen	Hold Time	5s	Screen	Hold Time	5s	Screen	Hold Time	5s
Screen	ID Gain	Off	Screen	ID Gain	Off	Screen	ID Gain	Off

COINS PROGRAM			FAST PROGRAM			ULTRA FAST PROGRAM		
Page	Setting	Factory value	Page	Setting	Factory value	Page	Setting	Factory value
Engine	Frequency	M1	Engine	Frequency	18.0 kHz	Engine	Frequency	18.0 kHz
Engine	Hot Rock	0	Engine	Hot Rock	0	Engine	Hot Rock	0
Engine	Reaction	5	Engine	Reaction	6	Engine	Reaction	8
Engine	Boost	20	Engine	Boost	30	Engine	Boost	30
Audio	Th Level	0	Audio	Th Level	0	Audio	Th Level	0
Audio	Th Tone	250	Audio	Th Tone	250	Audio	Th Tone	250
Audio	Th Sens	0	Audio	Th Sens	0	Audio	Th Sens	0
Audio	SAT	20	Audio	SAT	20	Audio	SAT	20
Audio	VCO	20	Audio	VCO	20	Audio	VCO	20
Audio	Audio Gain	20	Audio	Audio Gain	20	Audio	Audio Gain	20
Audio	Iron Vol.	0	Audio	Iron Vol.	0	Audio	Iron Vol.	0
Audio	Tones	Coin 3	Audio	Tones	Coin 1	Audio	Tones	Coin 1
Screen	ID Type	12 (-90+90)	Screen	ID Type	12 (-90+90)	Screen	ID Type	12 (-90+90)
Screen	Hold Time	5s	Screen	Hold Time	5s	Screen	Hold Time	5s
Screen	ID Gain	Off	Screen	ID Gain	Off	Screen	ID Gain	Off

USER PROGRAM – factory value the same as in Basic program											
Page	Setting	1	2	3	4	5	1	2	3	4	5
Engine	Frequency										
Engine	Hot Rock										
Engine	Reaction										
Engine	Boost										
Audio	Th Level										
Audio	Th Tone										
Audio	Th Sens										
Audio	SAT										
Audio	VCO										
Audio	Audio Gain										
Audio	Iron Vol.										
Audio	Tones										
Screen	ID Type										
Screen	Hold Time										
Screen	ID Gain										

EU DECLARATION OF CONFORMITY



Manufacturer: RUTUS Arkadiusz Rutyna, ul. Krakowska 32, 84-230 Rumia, Poland

Product: Metal detector Atrex

We declare under our sole responsibility that the mentioned product complies with all relevant provisions of the directives 2014/30/EU, 2014/35/EU, 2014/53/EU and complies with the following harmonized standards:

ETSI EN 300 328: v2.2.2:2019
ETSI EN 303 454 V1.1.1:2018
ETSI EN 301 489-1:2019 V2.2.3:2019
ETSI EN 301 489-17 V3.2.4:2020
ETSI EN 300440 v2.1.1:2017
EN 62311:2020
EN 62479:2010
EN 62368-1:2020+A11:2020

RUTUS
Arkadiusz Rutyna
ul. Krakowska 32
84-230 Rumia
Poland
tel. + 48 58 679 33 14
+ 48 601 284 371
rutus@rutus.com.pl
www.rutus.com.pl

The symbol of a crossed out dustbin means that the product cannot be disposed of with household waste. It is the user's responsibility to take the used equipment to a waste disposal site which has the facilities to handle electrical and electronic equipment. By ensuring this equipment is handled correctly you help to protect the environment. For more information about how to recycle this product please contact your local authority, waste removal provider or the shop where this product was purchased.

